

# Quick Start Cobi 18

USER GUIDE AND OPERATIONAL MANUAL



**ICE ROBOTICS**

# Unpack the Machine

1 Remove the 4 clips that hold the upper box onto the base.

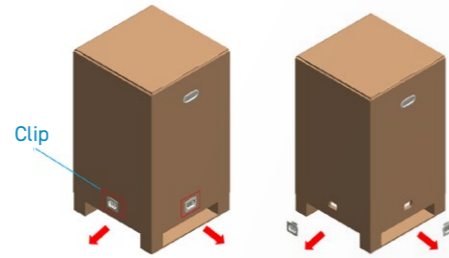

2 With 2 people, hold the handles on the outer box, pull it up and remove it completely.

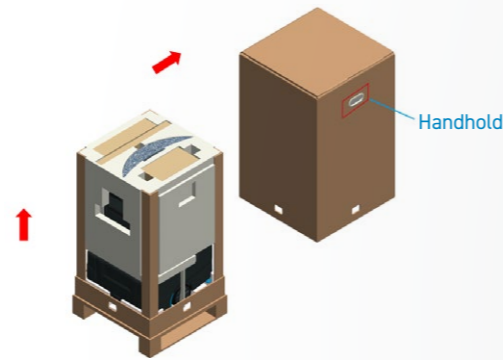

3 Remove the accessories box stored on the top of the packaging, it includes main brush, squeegee, mop, side brushes and hopper.

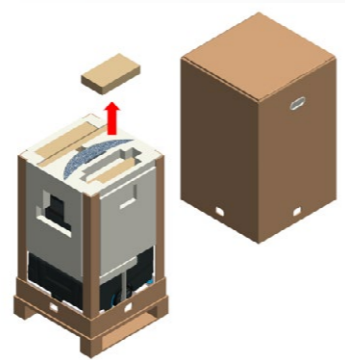

4 Continue to remove the packaging materials, including the upper foam and corner supports, fully exposing the machine.

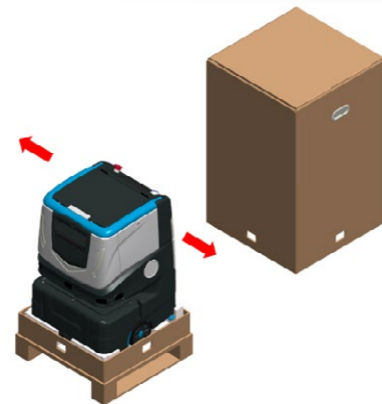

5 With 2 people, lift the unit up and take it out from the bottom box, then set it on the floor gently.



6 Remove the protective film from the Binocular Camera Module and 3D TOF.

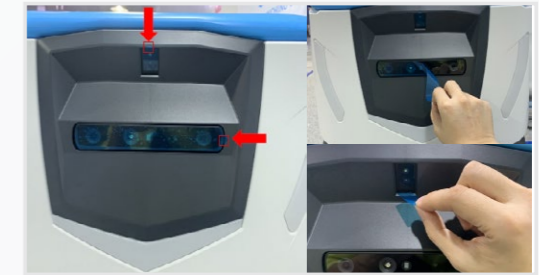

7 Gently lay the machine on its back on the floor with its front facing upwards, and remove the protective film from the cliff sensors.

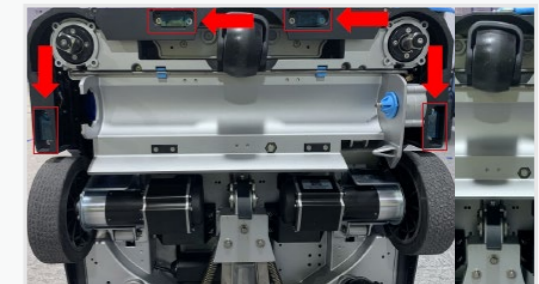

# Machine Setup and Installation

## 1. Main Brush Install and Removal

- Check and ensure the machine is turned off.
- Remove the tank assembly, mop and squeegee.
- Gently lay the machine on its back on the floor with its front facing upwards.
- Open the right-side door, hold the installing hub of the main brush, ensure the socket on the end aligns to the driving gear correctly, turn left to lock the hub and install the main brush.
- Close the right-side door, gently raise the machine and put it in the upright position.

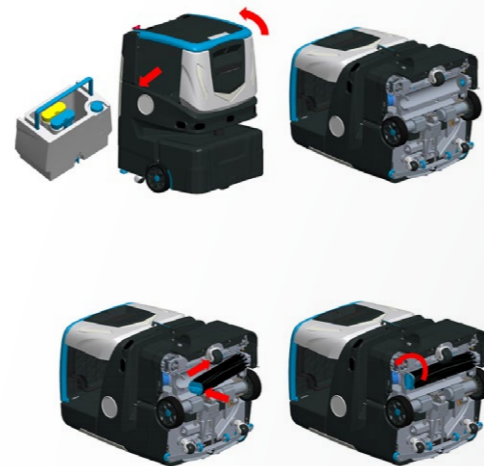

## 2. Side Brushes Install and Removal

- Open the left side door, hold the side brush and ensure the install socket is properly aligned to the drive gear, simply push it up to lock and install. Same procedure to install the right-side brush.
- Close the side door.



## 3. Hopper Installation

- Open the right-side door, hold the hopper on the end and ensure the magnetic surface faces up, simply push it in to lock and install.
- Close the side door.



## 4. Squeegee Install and Removal

- Hold the squeegee by pinching the 2 holders, ensuring the magnetic surface faces upwards, simply lift it up to lock and install. Pull it down to unlock and remove.



## 5. Mop Install and Removal

- Ensure the squeegee is installed on the machine before installing the mop.
- Attach the microfiber cloth mop on the mop holder via hook & loop before installing the mop.
- Hold the mop and align the socket on the mop holder and the hook on the squeegee holder, push it down to lock and install the mop.



## 6. Filling the Solution Tank

- Check and ensure the machine is turned off.
- Raise the transport handle, lift the tank handle, then remove the tank assembly .
- Remove the solution tank cap. Fill solution tank with clean water and the appropriate cleaning detergent. Install tank back on the machine, ensuring the rubber stands align to the tank holder base.
- Check around the machine and ensure there are not any water leaks.



## 7. Charge the Battery

- Make sure the battery power button is turned on.
- Plug battery power cord into approved power outlet to charge the battery. Keep the battery door open for ventilation.
- Store the machine in an approved area. Folding the handle down will set the parking brake for secure storage.



# Starting Up the Machine

## BEFORE EACH SHIFT



- Unplug and store power cord.



- Turn battery power on.



- Fill solution tank with water and appropriate chemical.



- Check cliff and lidar sensors are clean.
- Wipe with dry or lightly damp microfiber cloth.

- 1 Press the main power switch and the touch screen will power up.



- 2 Check the screen for warning messages. If a message appears, touch the message and follow instructions on how to clear the warning. If warning fails to clear, please contact [ICE Robotics customer service](#).



- 3 Enter the start up code: 657870

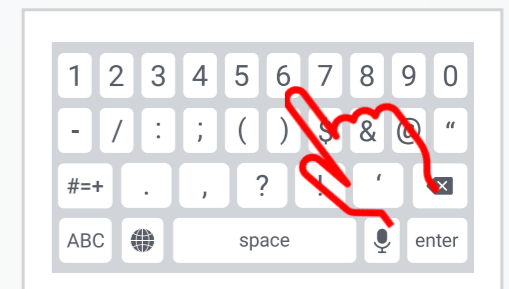

## Placing Home Location Code

Place Home Location Codes on walls, columns, etc. in a well-lit location and approximately 60 cm/23.6in from the floor and approximately 80 cm/31.5in from the machine.

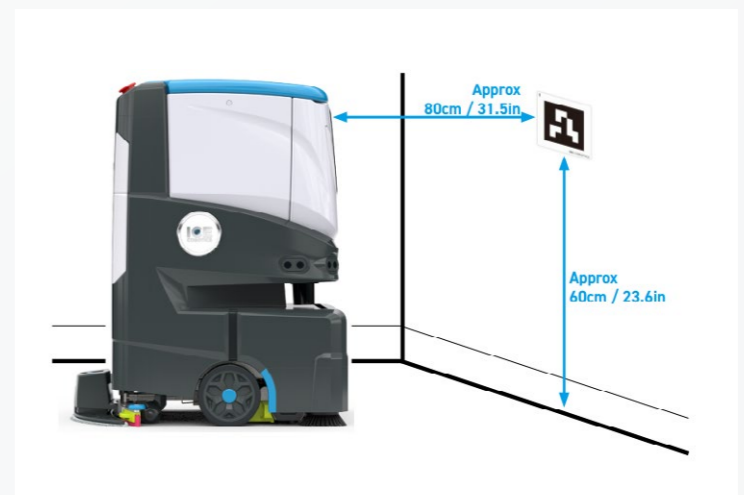

# Teach a Cleaning Route

1 Select the Autonomous mode by touching the icon [A] on the screen.

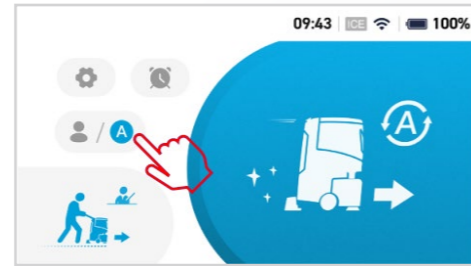

2 Select the cleaning route "teach mode" by touching the corresponding icon on the screen.

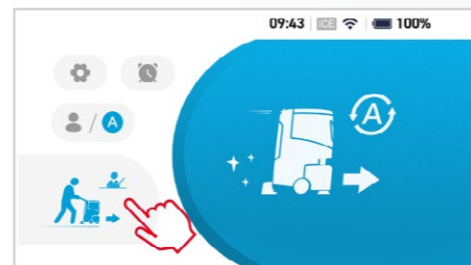

3 Push the machine to the front of the Home Location Code and scan it.

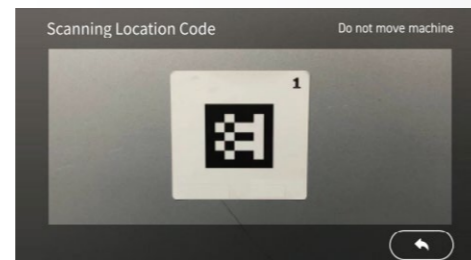

4 Touch the [+] icon to add a cleaning route.



5 Cobi 18 has two different cleaning route modes. Custom mode and Auto-fill mode. Select the mode you want by touching the corresponding icon.



6 Release the handle and push the GO/STOP button as shown on the animation on the control panel. The vacuum and brush motors will automatically turn on and the machine is now ready to be taught a route.



7 Push the machine along the route you wish to clean. The machine will learn the route you teach it. You may switch between ECO mode and MAX mode as needed.

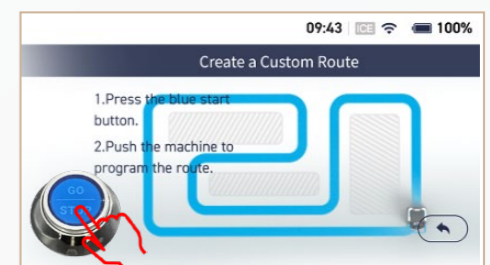

8 Once the route teaching is finished, push the machine back to the location code and direct the front camera to the location code. Touch the save icon and the machine will scan the location code and save the new cleaning route.

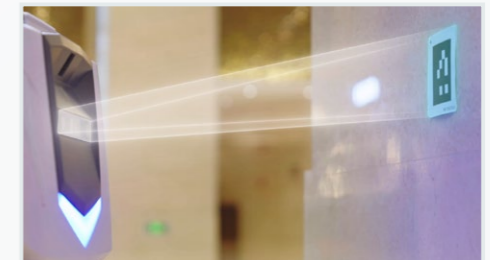

9 When the route has saved successfully, push the home icon and return to the autonomous mode interface. The cleaning route is now completed.

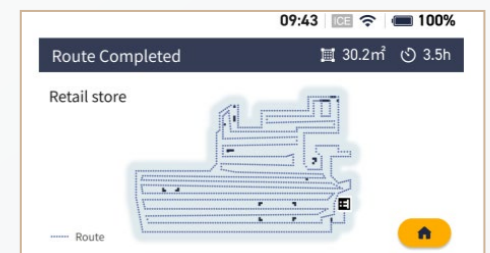

## ROUTE MODES

### Custom Route

The machine will follow the exact cleaning route it is taught.

### Auto-Fill Route

Teach the outline of the area you want to clean, and the machine will automatically fill in the route when in Autonomous Mode.

# Run Autonomous Mode

1 Select the Autonomous mode by touching the icon [A] on the screen.

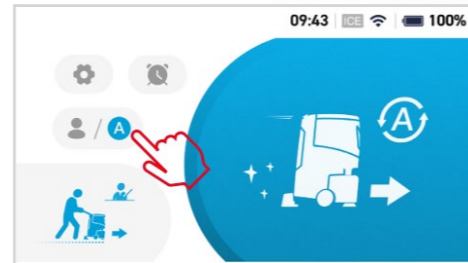

2 Select "run route" by touching the corresponding icon on the screen.

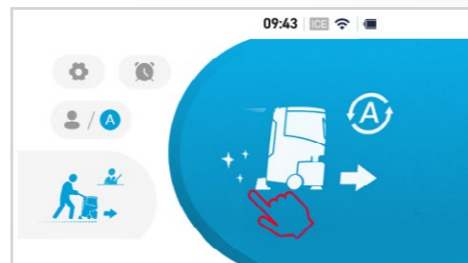

3 Push the machine to the front of the Home Location Code and scan it.

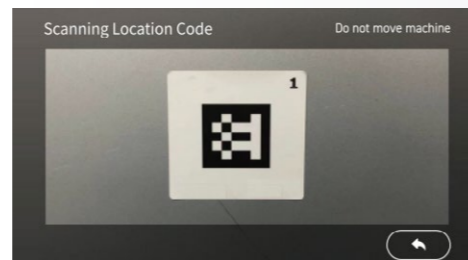

4 Touch the [+] icon to add a cleaning route.

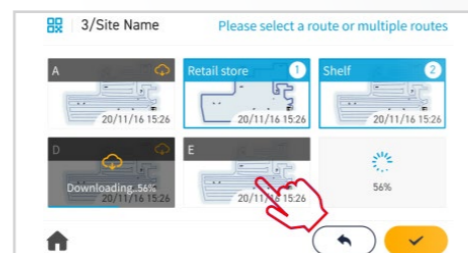

5 There are three possible cleaning modes when in Autonomous mode. Select the mode you want and push/tap the corresponding icon. Select the number of times you want to run the route and then push/tap the check mark to confirm your selection.

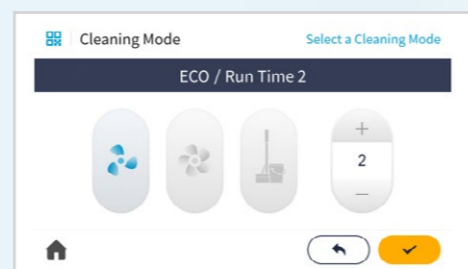

6 Lock the handle and push the GO/STOP button according to the animation on the screen. The vacuum and brush motors will turn on and the machine will begin to work in Autonomous mode.



## AFTER EACH SHIFT

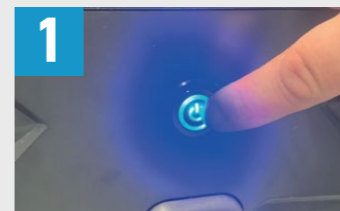

1 Turn off main power.



2 Empty and rinse solution and recovery tanks.

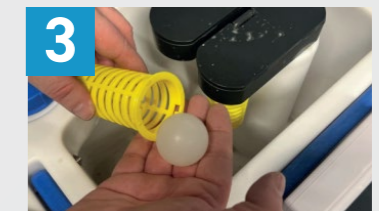

3 Remove recovery tank float-ball and rinse clean.



4 Remove squeegee assembly, clean by flushing water and wiping with clean cloth.



5 Remove and clean hopper.

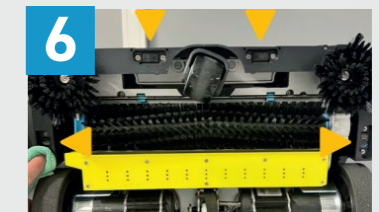

6 Wipe off the four cliff sensors with microfiber cloth.



7 Plug machine into approved outlet.



8 Keep battery on (blue) when charging.



9 Leave tank cover open so it can dry naturally.

## CLEANING MODES

### ECO Mode

The machine will work in energy-saving mode. It is applicable for lighter duty scrubbing or when cleaning in a noise sensitive environment.

### Max Mode

The machine will work at full power, it is applicable for scrubbing heavily soiled floors.

### Mop Only Mode

Only the drive motors will be operational and the mop will pick up pre-existing moisture on the floor.

# Other Cleaning Options

## Manual mode

- 1 Tap the Manual Mode icon on the main user interface as shown.
- 2 Tap the 1-step start icon as shown.
- 3 Click the icon of cleaning mode selection and switch the cleaning mode between ECO mode and Max mode as you desire.
- 4 Push the machine to the area you want to clean. To prevent any damage to the floor, keep machine moving forward while in operation.
- 5 Tap the 1-step start icon to end manual cleaning. The brush motor will stop immediately, the vacuum motor will shut off after 15 seconds and the screen display will return to the manual mode main interface.

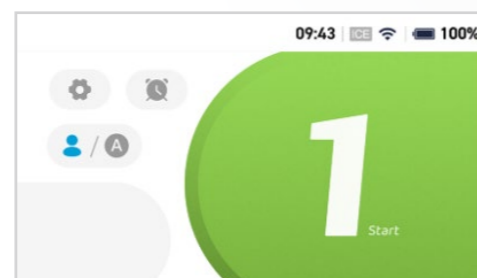
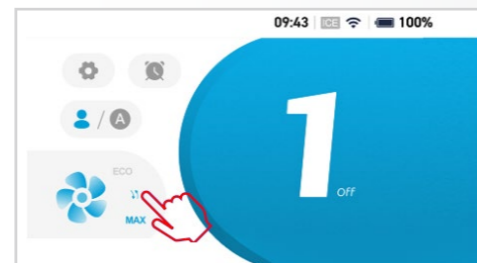
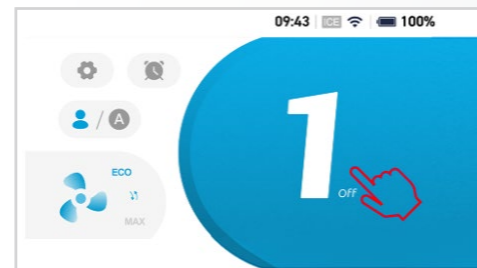
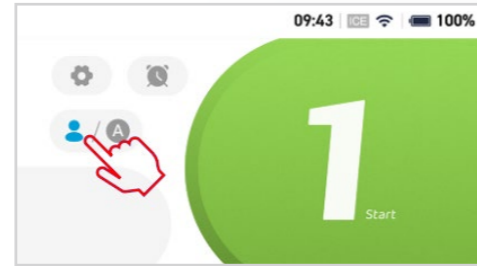

## Schedule Start

- 1 Select the Schedule Start by clicking the icon on the screen.
- 2 Click the [+] icon to add timing task.
- 3 Push the machine to the front of the Home Location code and scan it.
- 4 Push the corresponding icon to select the Cleaning Route(s) that you want to clean, then click on the icon of to confirm your selection.
- 5 Select the cleaning mode and repeat the number of times desired.
- 6 Set the cleaning time as you desire, turn on to start the cleaning task every day. Touch the to save the new timing task.

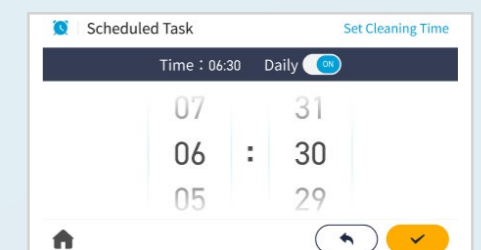
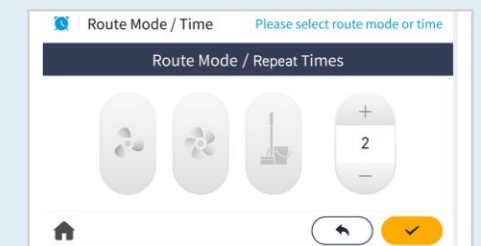
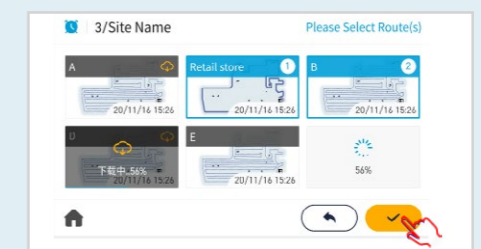
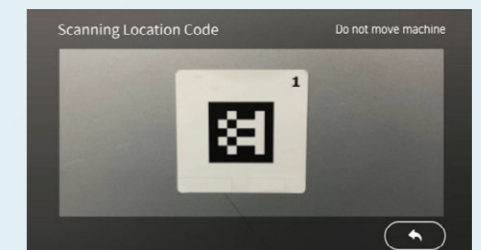
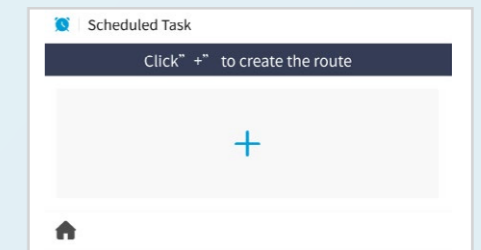

# Confirming Clean with i-SYNERGY APP

1 Log in to the customer APP.

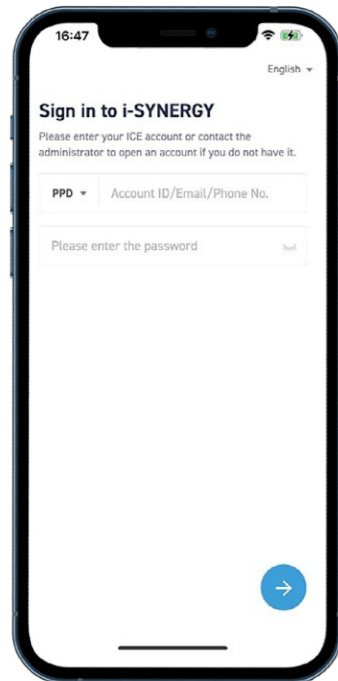

2 View your overall clean score for all sites. To view individual sites, click into the location card.

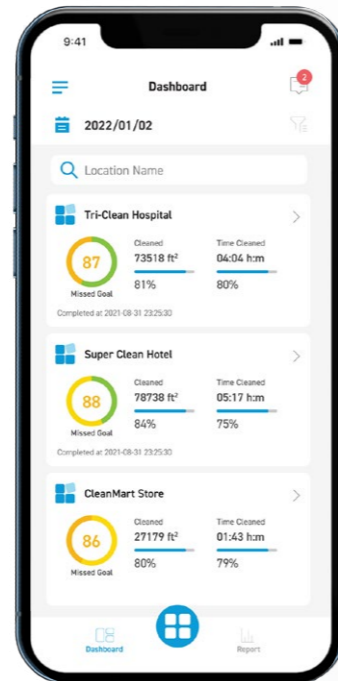

3 View individual sites clean scores. To drill down by machine, click into the site card.

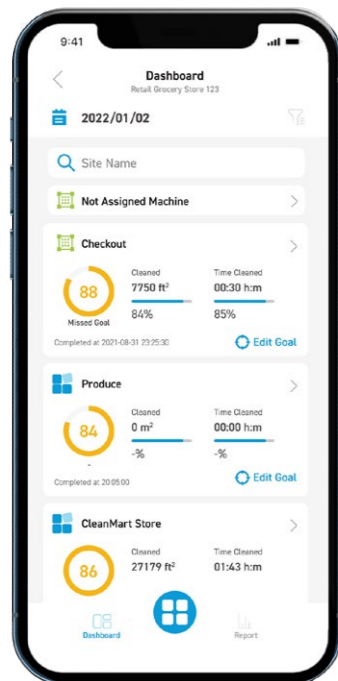

4 View machine data by site. To view individual machine data, click into the machine card.

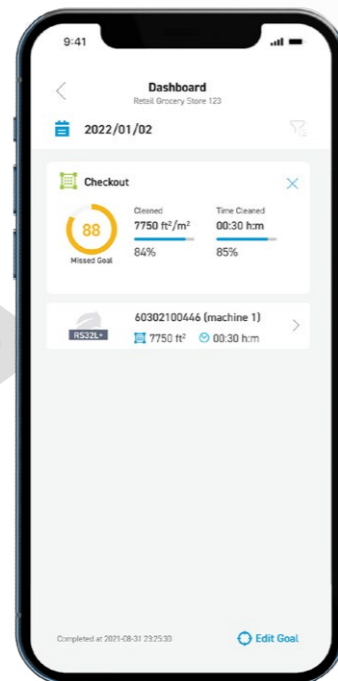

4 Here you can find detailed information for each machine. Click "Cleaning time (Daily)", "Cleaning Report (Monthly)" or "Cleaning Record" to confirm the clean on the APP.

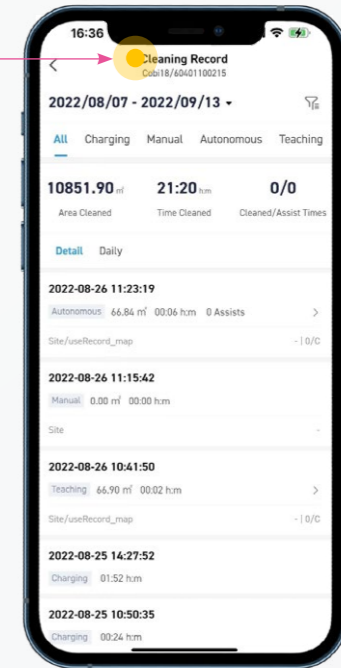
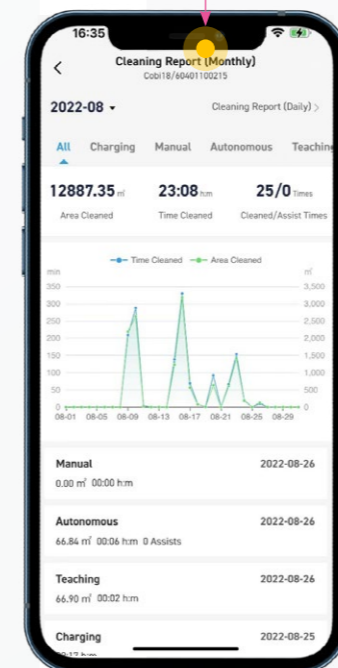
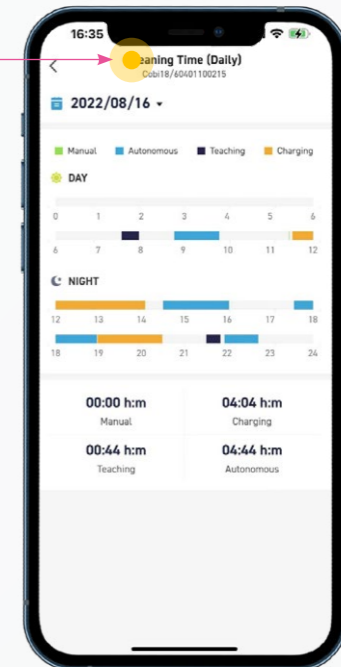
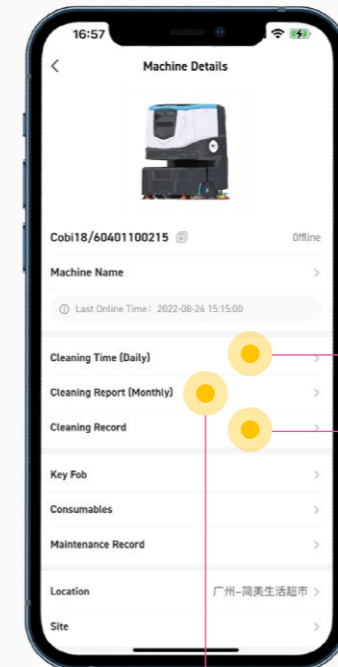



Subscribe to Smarter Cleaning

**ICE ROBOTICS**